

# DENON

## AV SURROUND RECEIVER

# AVR-2500

## OPERATING INSTRUCTIONS

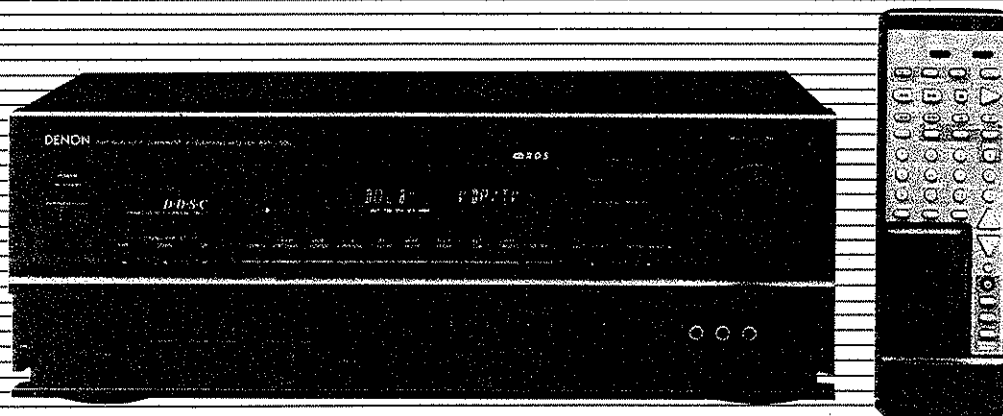

The photograph shows the AVR-2500 (black).  
(without side wood boards)

Manufactured under license from Dolby Laboratories Licensing Corporation. Additionally licensed under Canadian patent number 1,037,877. "Dolby," "Pro Logic," and the double-D symbol are trademarks of Dolby Laboratories Licensing Corporation.

- We greatly appreciate your purchase of the AVR-2500.
- To be sure you take maximum advantage of all the features the AVR-2500 has to offer, read these instructions carefully and use the set properly. Be sure to keep this manual for future reference should any questions or problems arise.

"SERIAL NO. \_\_\_\_\_"

PLEASE RECORD UNIT SERIAL NUMBER ATTACHED TO THE REAR OF THE  
CABINET FOR FUTURE REFERENCE"



## TABLE OF CONTENTS

<p><b>1</b> Introduction ..... 2~4</p> <p><b>2</b> Connections ..... 5~8</p> <p><b>3</b> Remote Control Unit</p> <p>3-1 System code buttons ..... 9</p> <p>3-2 Preset memory ..... 10, 11</p> <p>3-3 Remote control unit learning function ..... 12</p> <p><b>4</b> Operations</p> <p>4-1 Preparations for playback ..... 13</p> <p>4-2 Playing the program source (stereo play back) ..... 13</p> <p>4-3 Adjusting the BALANCE control and TONE control ..... 14</p> <p>4-4 Simulcast play back ..... 14</p> <p>4-5 Using the muting function ..... 14</p> <p>4-6 Listen with headphones ..... 14</p> <p>4-7 Multi-Source recording/playback ..... 15</p> <p>4-8 Using the surround function ..... 15~17</p>	<p><b>5</b> Listening to the radio</p> <p>5-1 Auto preset memory ..... 18</p> <p>5-2 Auto tuning ..... 18</p> <p>5-3 Manual tuning ..... 18</p> <p>5-4 Preset memory ..... 18</p> <p>5-5 Recalling preset stations ..... 19</p> <p>5-6 RDS (Radio Data System) ..... 19</p> <p>5-7 RDS search ..... 20</p> <p>5-8 PTY search ..... 20</p> <p>5-9 TP search ..... 21</p> <p>5-10 RT (Radio Text) ..... 21</p> <p><b>6</b> Easy Operation Functions</p> <p>6-1 On screen display ..... 22</p> <p>6-2 Front panel display ..... 22</p> <p>6-3 Personal memory ..... 22</p> <p>6-4 System call (Remote control unit) ..... 22</p> <p><b>7</b> Initialization of the Microprocessor ..... 22</p> <p><b>8</b> Last function memory ..... 23</p> <p><b>9</b> Troubleshooting ..... 23</p> <p><b>10</b> Specifications ..... 24</p>
---	---

### • ACCESSORIES

Check that the following parts are included in addition to the main unit:

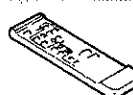
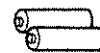
① Operating instructions ..... 1	② Warranty (for North American model only) ..... 1	③ Remote control unit (RC-180) ..... 1	④ R6P/AA batteries ..... 2	⑤ AM loop antenna ..... 1	⑥ FM indoor antenna ..... 1
----------------------------------	--	---	----------------------------	---------------------------	-----------------------------

## **1** INTRODUCTION

### SAFETY PRECAUTIONS



**CAUTION**

**RISK OF ELECTRIC SHOCK**

**DO NOT OPEN**



**CAUTION: TO REDUCE THE RISK OF ELECTRIC SHOCK, DO NOT REMOVE COVER (OR BACK). NO USER SERVICEABLE PARTS INSIDE. REFER SERVICING TO QUALIFIED SERVICE PERSONNEL.**



The lightning flash with arrowhead symbol, within an equilateral triangle, is intended to alert the user to the presence of uninsulated "dangerous voltage" within the product's enclosure that may be of sufficient magnitude to constitute a risk of electric shock to persons.



The exclamation point within an equilateral triangle is intended to alert the user to the presence of important operating and maintenance (servicing) instructions in the literature accompanying the appliance.

**WARNING: TO REDUCE THE RISK OF FIRE OR ELECTRIC SHOCK, DO NOT EXPOSE THIS APPLIANCE TO RAIN OR MOISTURE.**

**CAUTION**

TO PREVENT ELECTRIC SHOCK DO NOT USE THIS (POLARIZED) PLUG WITH AN EXTENSION CORD, RECEPTACLE OR OTHER OUTLET UNLESS THE BLADES CAN BE FULLY INSERTED TO PREVENT BLADE EXPOSURE.

**ATTENTION**



POUR PREVENIR LES CHOCS ELECTRIQUES NE PAS UTILISER CETTE FICHE POLARISEE AVEC UN PROLONGATEUR UNE PRISE DE COURANT OU UNE AUTRE SORTIE DE COURANT, SAUF SI LES LAMES PEUVENT ETRE INSEREES A FOND SANS EN LAISSER AUCUNE PARTIE A DECOUVERT.

# SAFETY INSTRUCTIONS

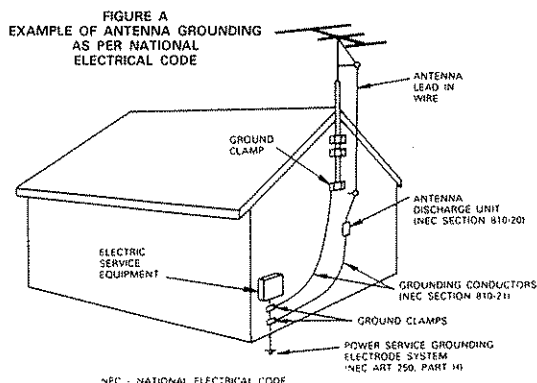
1. Read Instructions – All the safety and operating instructions should be read before the appliance is operated.
2. Retain Instructions – The safety and operating instructions should be retained for future reference.
3. Heed Warnings – All warnings on the appliance and in the operating instructions should be adhered to.
4. Follow Instructions – All operating and use instructions should be followed.
5. Water and Moisture – The appliance should not be used near water – for example, near a bathtub, washbowl, kitchen sink, laundry tub, in a wet basement, or near a swimming pool, and the like.
6. Carts and Stands – The appliance should be used only with a cart or stand that is recommended by the manufacturer.
- 6A. An appliance and cart combination should be moved with care. Quick stops, excessive force, and uneven surfaces may cause the appliance and cart combination to overturn.
7. Wall or Ceiling Mounting – The appliance should be mounted to a wall or ceiling only as recommended by the manufacturer.
8. Ventilation – The appliance should be situated so that its location or position does not interfere with its proper ventilation. For example, the appliance should not be situated on a bed, sofa, rug, or similar surface that may block the ventilation openings; or, placed in a built-in installation, such as a bookcase or cabinet that may impede the flow of air through the ventilation openings.
9. Heat – The appliance should be situated away from heat sources such as radiators, heat registers, stoves, or other appliances (including amplifiers) that produce heat.
10. Power Sources – The appliance should be connected to a power supply only of the type described in the operating instructions or as marked on the appliance.
11. Grounding or Polarization – Precautions should be taken so that the grounding or polarization means of an appliance is not defeated.
12. Power-Cord Protection – Power-supply cords should be routed so that they are not likely to be walked on or pinched by items placed upon or against them, paying particular attention to cords at plugs, convenience receptacles, and the point where they exit from the appliance.
14. Cleaning – The appliance should be cleaned only as recommended by the manufacturer.
15. Power Lines – An outdoor antenna should be located away from power lines.
16. Outdoor Antenna Grounding – If an outside antenna is connected to the receiver, be sure the antenna system is grounded so as to provide some protection against voltage surges and built-up static charges. Article 810 of the National Electrical Code, ANSI/NFPA 70, provides information with regard to proper grounding of the mast and supporting structure, grounding of the lead-in wire to an antenna-discharge unit, size of grounding conductors, location of antenna-discharge unit, connection to grounding electrodes, and requirements for the grounding electrode. See Figure A.
17. Nonuse Periods – The power cord of the appliance should be unplugged from the outlet when left unused for a long period of time.
18. Object and Liquid Entry – Care should be taken so that objects do not fall and liquids are not spilled into the enclosure through openings.
19. Damage Requiring Service – The appliance should be serviced by qualified service personnel when:
  - A. The power-supply cord or the plug has been damaged; or
  - B. Objects have fallen, or liquid has been spilled into the appliance; or
  - C. The appliance has been exposed to rain; or
  - D. The appliance does not appear to operate normally or exhibits a marked change in performance; or
  - E. The appliance has been dropped, or the enclosure damaged.
20. Servicing – The user should not attempt to service the appliance beyond that described in the operating instructions. All other servicing should be referred to qualified service personnel.

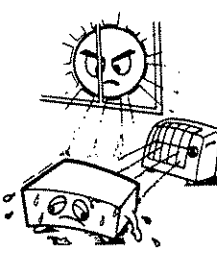
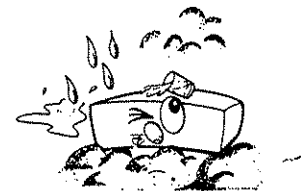
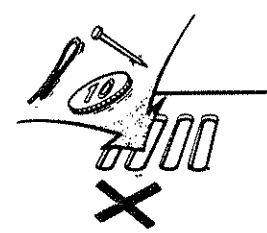
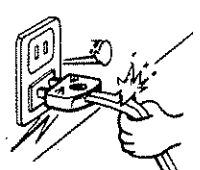
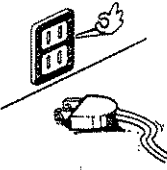

● NOTE ON USE

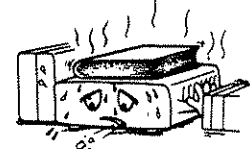
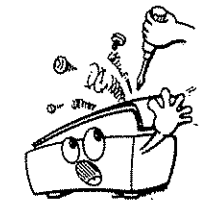
 <ul style="list-style-type: none"> <li>● Avoid high temperatures Allow for sufficient heat dispersion when installed on a rack.</li> </ul>	 <ul style="list-style-type: none"> <li>● Keep the set free from moisture, water, and dust.</li> </ul>	 <ul style="list-style-type: none"> <li>● Do not let foreign objects in the set.</li> </ul>
 <ul style="list-style-type: none"> <li>● Handle the power cord carefully. Hold the plug when unplugging the cord.</li> </ul>	 <ul style="list-style-type: none"> <li>● Unplug the power cord when-not using the set for long periods of time.</li> </ul>	 <ul style="list-style-type: none"> <li>● Do not let insecticides, benzene, and thinner come in contact with the set.</li> </ul>
 <p>*(For sets with ventilation holes)</p> <ul style="list-style-type: none"> <li>● Do not obstruct the ventilation holes.</li> </ul>	 <ul style="list-style-type: none"> <li>● Never disassemble or modify the set in any way.</li> </ul>	

● INSTALLATION PRECAUTIONS

Using this receiver or other electronic equipment containing microprocessors simultaneously with a tuner or TV may result in noise in the sound or picture.

If this should happen, take the following steps:

- Install the receiver as far as possible from the tuner or TV set.
- Keep the antenna lines of the tuner or TV as far as possible from the receiver's power cord and connection cables.
- This problem is especially frequent when using indoor antennas. We recommend using outdoor antennas and 75 Ω /ohms coaxial cables.

A note on stacking

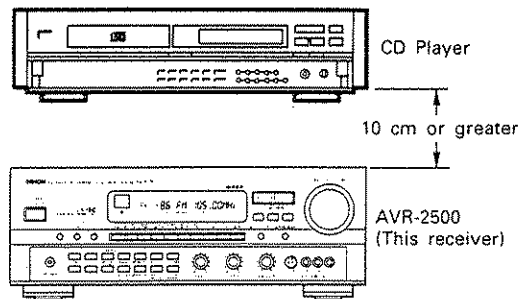

For cooling purposes, do not place another AV component directly on top of the receiver. Be sure to leave a space of at least 10 cm.

For models with side wood boards

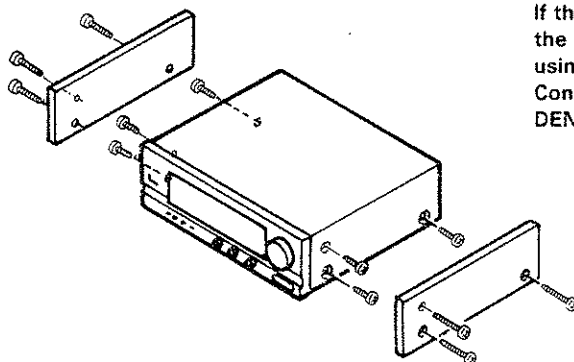

If the side wood boards are removed, the top cabinet cannot be reinstalled using the same screws. Consult your store of purchase or a DENON Overseas Service Center.

## 2 CONNECTIONS

- Do not plug in the power cord until all connections have been completed.
- Be sure to connect the left and right channels properly (left with left, right with right).
- Insert the plugs securely. Incomplete connections will result in the generation of noise.
- Use the AC OUTLETS for audio equipment only. Do not use them for hair driers, etc.
- Note that binding pin plug cords together with power cords or placing them near a power transformer will result in the introduction of hum or other noise.
- If hum or other noise is produced when the ground wire is connected, disconnect it.
- Noise or humming may be generated if a connected component is used independently without turning the power of the AVR-2500 on. If this happens, turn on the power of the AVR-2500.

### 2-1 Connecting the audio components

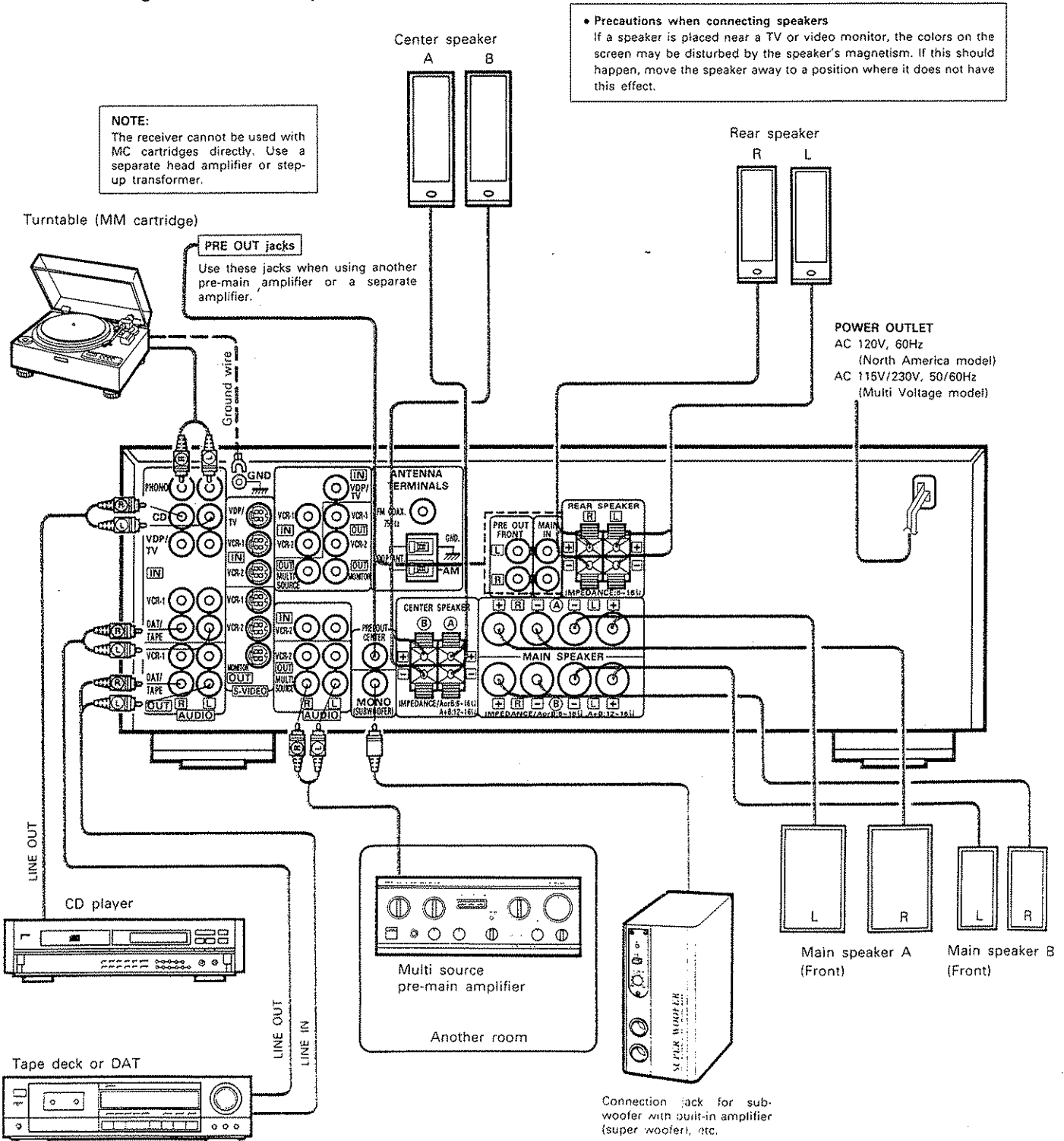

## 2-2 Speaker System Connections

- This receiver can accommodate connections of a total of eight speakers including two set of (front) main amplifier speakers (A and B), one set of rear speakers, and one or two center speakers.
- Connect the speaker terminals with the speakers making sure that like polarities are matched ( $\oplus$  with  $\oplus$ ,  $\ominus$  with  $\ominus$ ). Mismatching of polarities will result in weak central sound, unclear orientation of the various instruments, and the sense of direction of the stereo being impaired.
- When making connections, take care that none of the individual conductors of the speaker cord come in contact with adjacent terminals, with other speaker cord conductors, or with the rear panel.

### • Speaker Impedance

- When speaker systems A and B are use separately, speakers with an impedance of from 6 to 16  $\Omega$ /ohms can be connected.
- Be careful when using two pairs of main speakers (A + B) at the same time, since use of speakers with an impedance outside the range of 12 to 16  $\Omega$ /ohms will lead to damage.
- Speakers with an impedance of 6 to 12  $\Omega$ /ohms can be connected for use as center and rear speakers.
- The protection circuit may operate or damage may occur when speakers with an impedance outside of the above range are used.

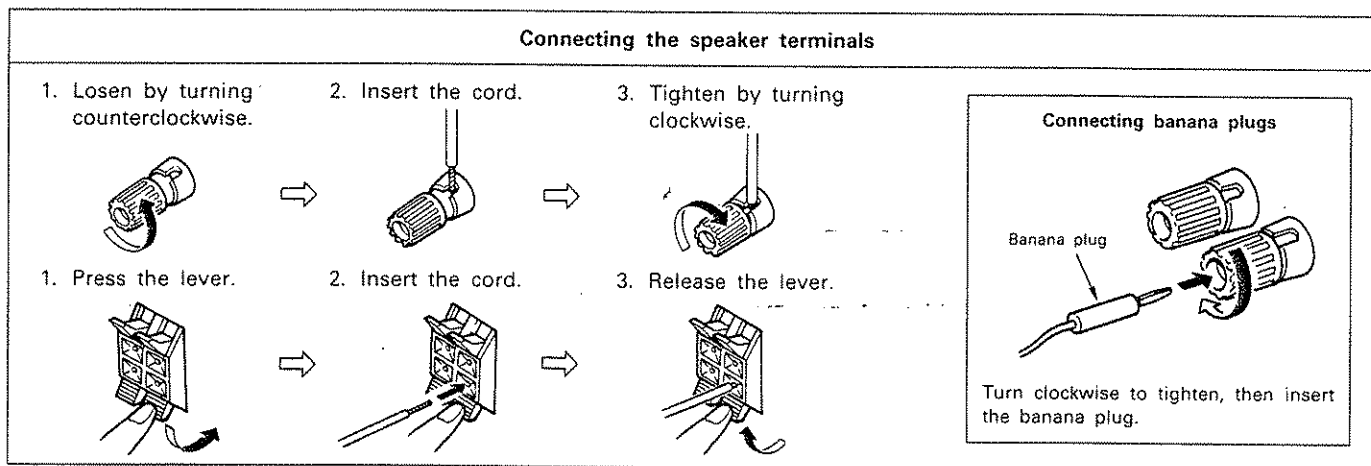

## 2-3 Connecting the antenna terminals

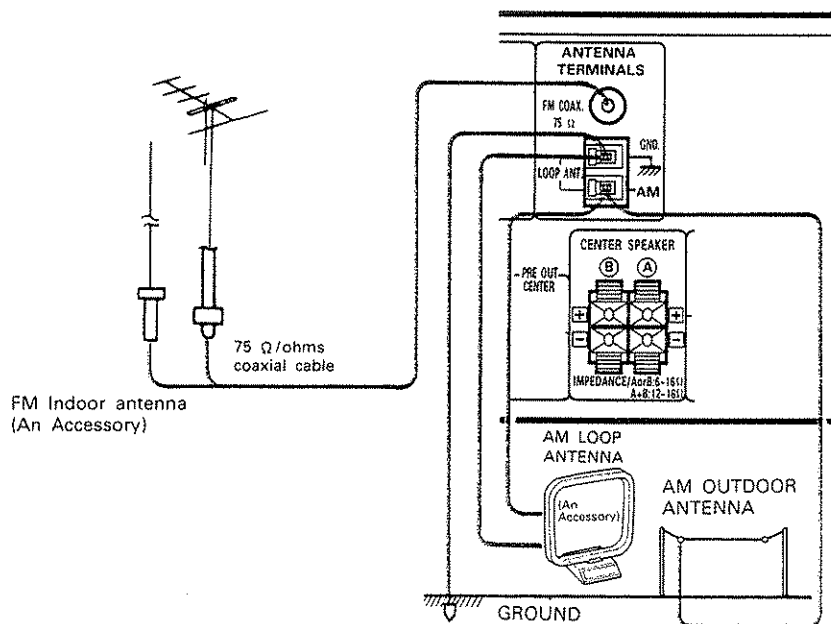

### ANTENNA INSTALLATION

#### • FM ANTENNA

The supplied FM antenna can be used inside wooden houses for receiving local FM stations and other strong FM signals. Stretch out the ends of the antenna and mount the antenna on the wall or ceiling where optimum reception is achieved. A indoor FM antennas may not consistently ensure stable reception, due to environment changes. In such cases, the indoor FM antenna should only be used temporarily until an outdoor FM antenna has been installed. When connecting an outdoor FM antenna, the use of 75 ohm coaxial cable (3C-2V, 5C-2V) is strongly recommended.

#### • AM ANTENNA

Attach the supplied AM loop antenna even when using an outdoor AM antenna. Connect the leads to the AM and GND terminals. Also use the AM terminals for connecting an outdoor AM antenna (when making such a connection do not disconnect the AM loop antenna.) Adjust the loop antenna to obtain optimum reception. Where broadcast stations are distant and only weak signals are received, or where signals are blocked, it is best to install an outdoor AM antenna.

#### NOTES

- This receiver has a full back-up system. When the power is turned on, the INPUT SELECTOR buttons are set to the last mode set before the power was turned off.
- When using this receiver in close proximity to video equipment (TV, VCR, VDP, etc.), noise may be generated in AM broadcasts. To avoid this, keep the receiver as far away from other video components as possible, or detach the AM loop antenna from the antenna holder and place it where noise is reduced. If the noise is not reduced, turn off the power of the video components when listening to AM broadcasts.

### Connection of AM antennas

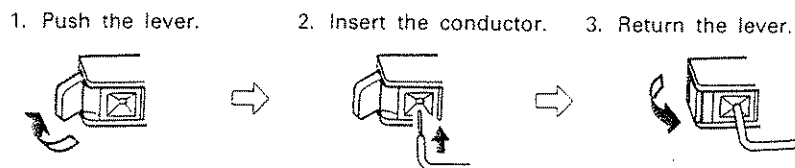

#### Note to CATV system installer:

This reminder is provided to call the CATV system installer's attention to Article 820-40 of the NEC which provides guidelines for proper grounding and, in particular, specifies that the cable ground shall be connected to the grounding system of the building, as close to the point of cable entry as practical.

## 2-4 Connecting the video components

To connect the video signal, connect using a 75 Ω/ohms video signal cable cord. Using an improper cable can result in a drop in sound quality.

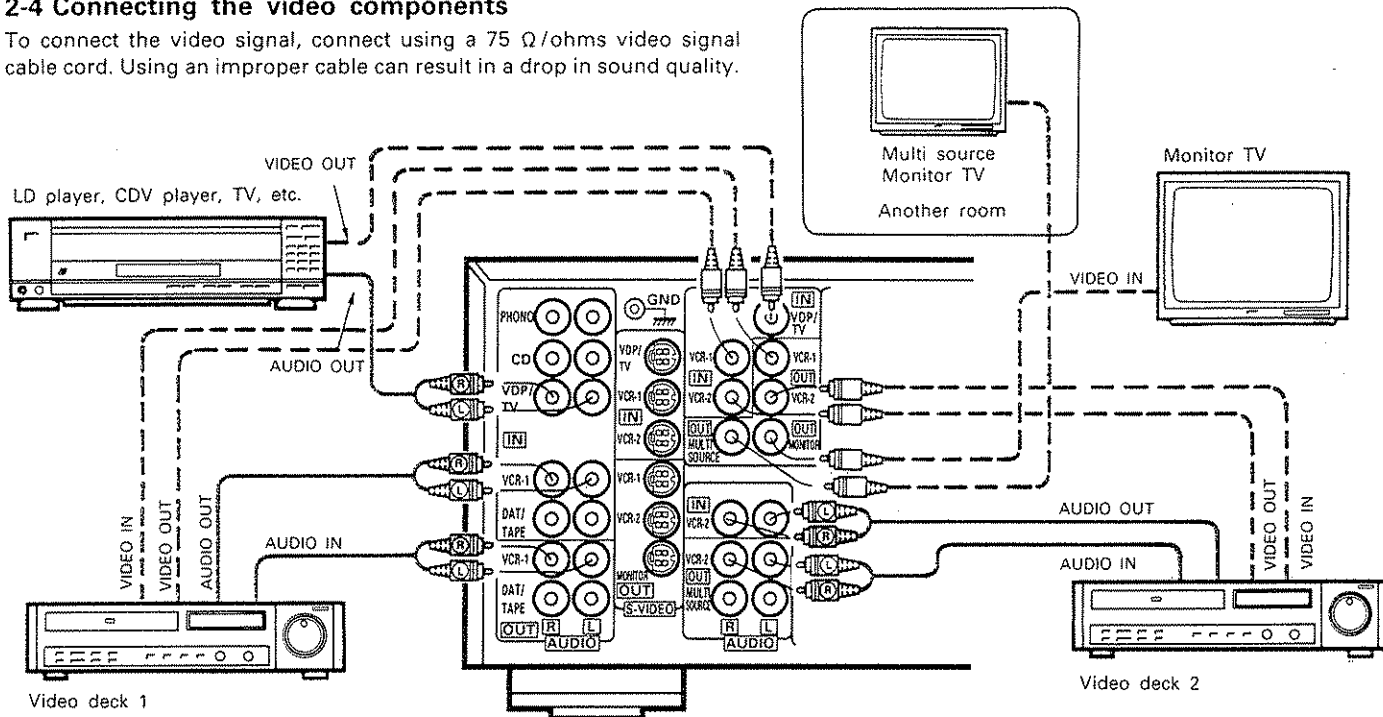

## 2-5 Connecting the S-video terminals

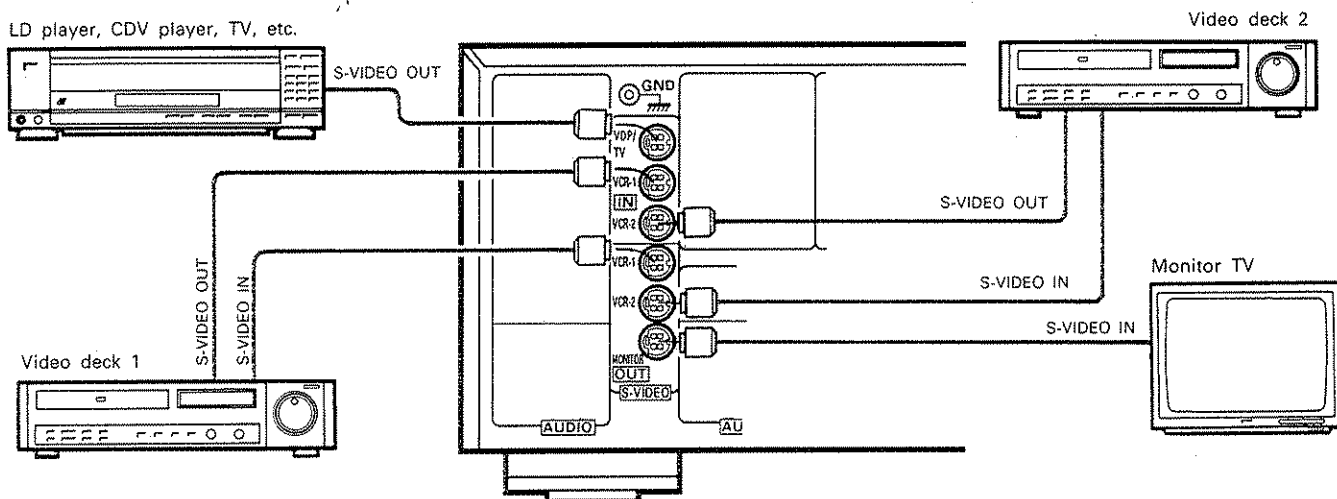

- **A note on the S input jacks**

The input selectors for the S inputs and pin jack inputs work in conjunction with each other.

- **Precaution when using S-jacks**

This receiver's S-jacks (input and output) and video pin jacks (input and output) have independent circuit structures, so that video signals input from the S-jacks are only output from the S-jack outputs and video signals input from the pin jacks are only output from the pin jack outputs.

When connecting the receiver with equipment that is equipped with S-jacks, keep the above point in mind and make connections according to the equipment instruction manuals.

## 2-6 Connecting camcorder or game (V-AUX/GAME)

This unit is equipped with VIDEO AUX jacks on the front panel for playback of video equipment or playing games.

Camcorder or Game

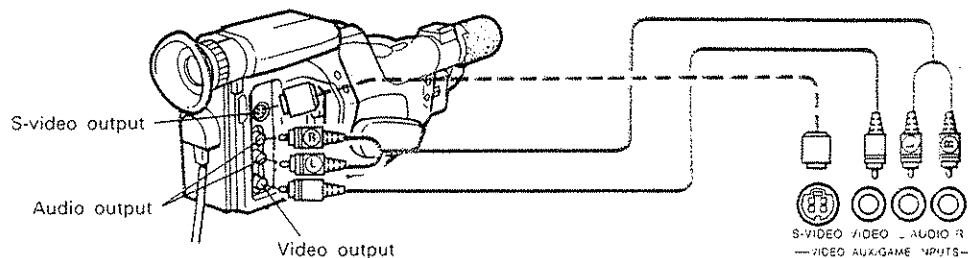

**■ NORTH AMERICA MODEL ONLY**

**● AC OUTLETS**

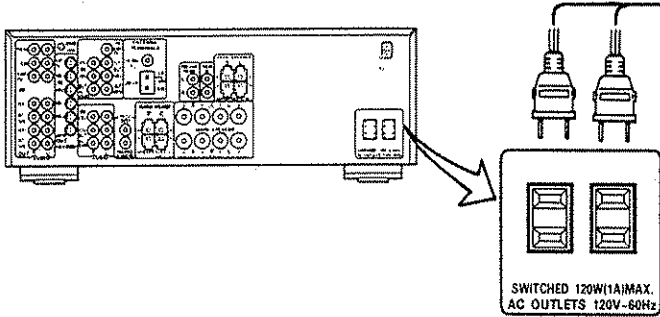

**Connecting the AC OUTLETS**

**AC OUTLETS**

- **SWITCHED** (total capacity – 120W (1A))

The power to this outlet is turned on and off in conjunction with the POWER switch on the AVR-2500, and when the power is switched between on and standby from the remote control unit. No power is supplied from these outlets when the AVR-2500's power is at standby. Never connect equipment whose total capacity is above 120W (1A).

**NOTE:**

Only use the AC outlets for audio equipment. Never use them for hair driers, TVs or other electrical appliances.

**■ MULTI-VOLTAGE MODEL ONLY**

Make the following settings before connecting the components.

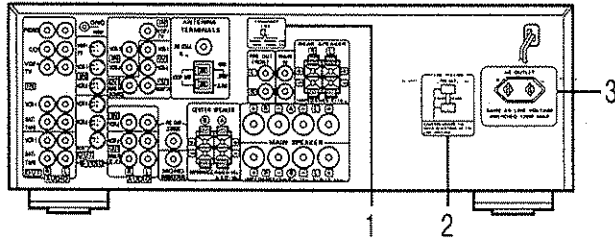

**1. Setting the frequency step**

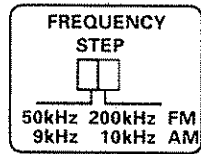

Set the FREQUENCY STEP switch as described below.

- In the U.S.A. and Canada – set the switch to 200 kHz / 10 kHz side. With this setting, the frequency varies in 200 kHz steps in the range of 87.5 to 107.9 MHz (FM) and in 10 kHz steps in 520 to 1710 kHz (AM).
- Elsewhere – set the switch to 50 kHz / 9 kHz side. With this setting, the frequency varies in 50 kHz steps in the range of 87.50 to 108.0 MHz (FM) and in 9 kHz steps in 522 to 1611 kHz (AM).

Only switch the frequency when the power cord is unplugged. Plug in the power cord securely after switching the frequency.

**2. Setting the line voltage**

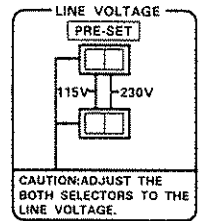

- The customer can set the VOLTAGE SELECTORS on the back panel for appropriate line voltage by using a screwdriver.
- Do not use excessive force in setting the VOLTAGE SELECTOR KNOB – you may damage it.
- If the VOLTAGE SELECTOR KNOB does not turn smoothly, contact your store of purchase.
- Be sure to set both voltage selectors to same position.

**3. AC OUTLET**

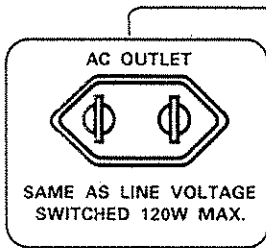

**Connecting the AC OUTLET**

**AC OUTLET**

- **SWITCHED** (total capacity – 120W)

This AC outlet is controlled by the power switch and Remote Control Unit. Maximum capacity is 120 W.

**NOTE:**

Only use the AC outlet for audio equipment. Never use them for hair driers, TVs or other electrical appliances.



### 3 REMOTE CONTROL UNIT

Following the procedure outlined below, insert the batteries before using the remote control unit.

#### Range of operation of the remote control unit

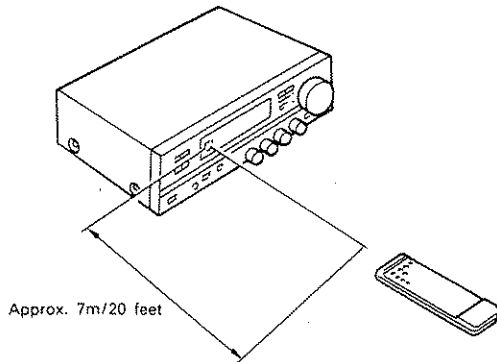

Point the remote control unit at the remote control sensor as shown on the diagram at the left.

#### NOTES:

- The remote control unit can be used from a straight distance of approximately 7 meters/20 feet, but this distance will shorten or operation will become difficult if there are obstacles between the remote control unit and the remote control sensor, if the remote control sensor is exposed to direct sunlight or other strong light, or if operated from an angle.
- Neon signs or other devices emitting pulse-type noise nearby may result in malfunction, so keep the set as far away from such devices as possible.

#### Inserting the batteries

1. Open the bottom cover of the remote control unit and remove the battery cover.

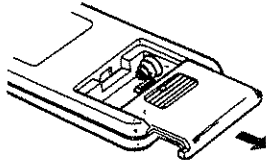

2. Insert the two R6P/AA batteries, matching the ⊕ and ⊖ marks on the batteries with those in the case. Close the bottom cover until it clicks shut.

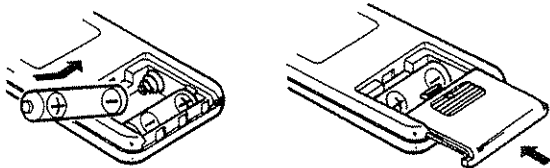

#### NOTES

- Use only AA, R6P, UM-3 batteries for replacement.
- Be sure the polarities are correct. (See the illustration inside the battery compartment.)
- Remove the batteries if the remote control transmitter will not be used for an extended period of time.
- If batteries leak, dispose of them immediately. Avoid touching the leaked material or letting it come in contact with clothing, etc. Clean the battery compartment thoroughly before installing new batteries.
- Have replacement batteries on hand so that the old batteries can be replaced as quickly as possible when the time comes.
- The codes that have been learned may be lost if removed batteries are not replaced within about 5 minutes.

#### 3-1 System code buttons

DENON remote-controllable audio components can be controlled using this unit's remote control unit. Note that some components, however, cannot be operated with this remote control unit.

1. Set to slide switch to "AUDIO" ("AVR/AVC").



2. Set the slide switch to the position for the component to be operated (CD, DECK or DAT).



3. Use the buttons shown below to operate the component.

For details, refer to the respective component's manual.

- a. For CD players and DATs

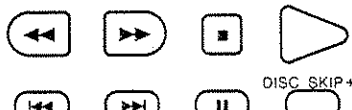

- b. For tape decks

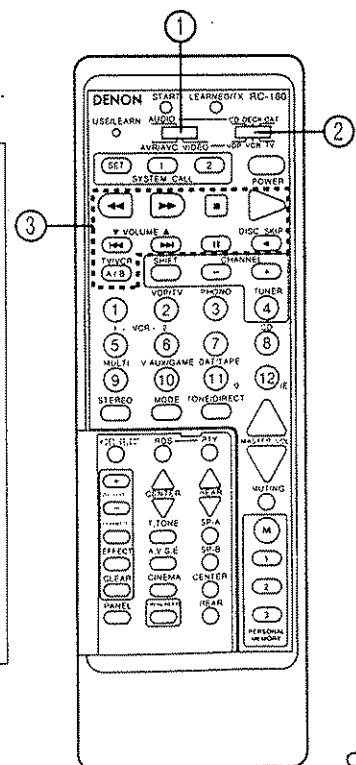
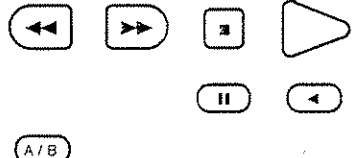

### 3-2 Preset memory

This remote control unit can be used to operate components of other manufacturers without using the learning function by registering the manufacturer of the component as shown on the diagrams below.

1. Set the slide switch to "VIDEO".



2. Set the slide switch to the component to be registered (VDP, VCR or TV).

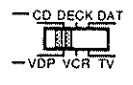

Ex.: To preset a VDP in the personal memory

3. Holding in the POWER button, press the button for the corresponding manufacturer in block A. (Refer to Table 1.)

Flashes

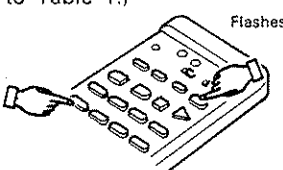

The LEARNED/TX LED flashes.

4. Next, while holding in the POWER button, press the button for the code in block B. (Refer to Table 1.) The operation is completed when the LEARNED/TX-LED lights.

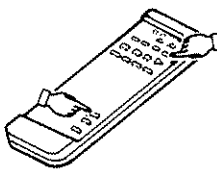

5. To continue registering other components, repeat steps 2 to 4.

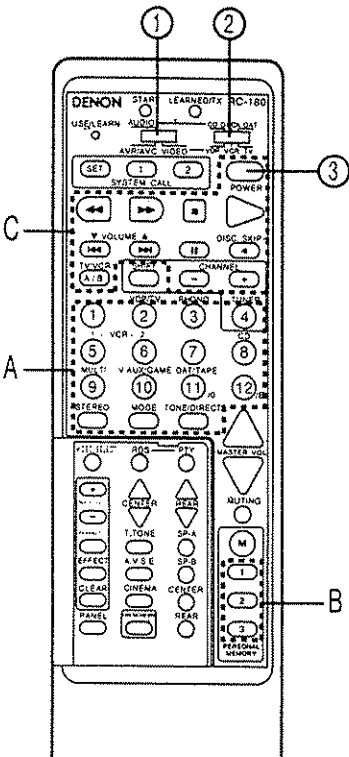

#### • Operation after components are registered

After components are registered, they can be operated using the buttons in block C shown below. For details, refer to the respective component's manual. Before operating the component, set slide switch ② to the position for that component.

#### 1. VDP

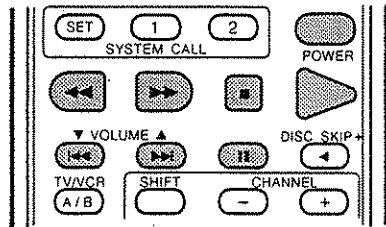

#### 2. VCR

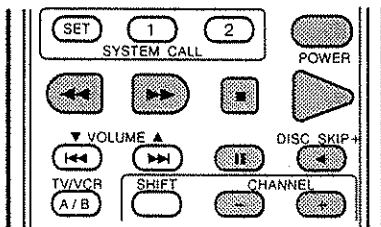

#### 3. TV

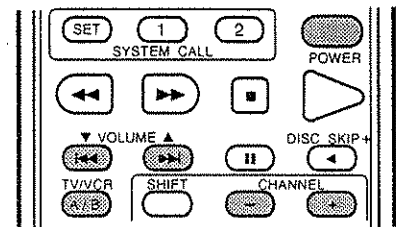

Table 1: Combinations of Personal System Codes for Different Manufacturers

#### "VDP"

A \ B	[1] button	[2] button	[3] button
1	DENON A	DENON B	DENON C
2 (VDP/TV)	—	—	—
3 (PHONO)	MITSUBISHI	—	—
4 (TUNER)	PANASONIC	—	—
5 (VCR-1)	—	—	—
6 (VCR-2)	SONY A	SONY B	SONY C
7	PIONEER	—	—
8 (CD)	—	—	—
9 (MULTI)	SANYO	—	—
10 (V.AUX/GAME)	SHARP	—	—
11/O (DAT/TAPE)	—	—	—
12/E	PHILIPS	—	—
STEREO	RCA	—	—
MODE	—	—	—
TONE/DIRECT	MAGNAVOX	—	—

#### "VCR"

A \ B	[1] button	[2] button	[3] button
1	—	—	—
2 (VDP/TV)	HITACHI A	HITACHI B	HITACHI C
3 (PHONO)	MITSUBISHI A	MITSUBISHI B	MITSUBISHI C
4 (TUNER)	PANASONIC A	PANASONIC B	—
5 (VCR-1)	JVC (VICTOR) A	JVC (VICTOR) B	—
6 (VCR-2)	SONY A	SONY B	SONY C
7	PIONEER	—	—
8 (CD)	TOSHIBA A	TOSHIBA B	—
9 (MULTI)	SANYO A	SANYO B	—
10 (V.AUX/GAME)	SHARP A	SHARP B	—
11/O (DAT/TAPE)	NEC A	NEC B	NEC C
12/E	PHILIPS A	PHILIPS B	PHILIPS C
STEREO	RCA A	RCA B	—
MODE	GENERAL ELECTRIC A	GENERAL ELECTRIC B	—
TONE/DIRECT	MAGNAVOX A	MAGNAVOX B	MAGNAVOX C

"TV"

A \ B	1 button	2 button	3 button
1	DENON	---	---
2 (VDP/TV)	HITACHI A	HITACHI B	---
3 (PHONO)	MITSUBISHI A	MITSUBISHI B	MITSUBISHI C
4 (TUNER)	PANASONIC	---	---
5 (VCR-1)	JVC (VICTOR)	---	---
6 (VCR-2)	SONY	---	---
7	PIONEER	---	---
8 (CD)	TOSHIBA	---	---
9 (MULTI)	SANYO B	SANYO A	---
10 (V.AUX/GAME)	SHARP	---	---
11/O (DAT/TAPE)	NEC A	NEC B	NEC C
12/E	PHILIPS A	PHILIPS B	PHILIPS C
STEREO	RCA A	RCA B	---
MODE	GENERAL ELECTRIC A	GENERAL ELECTRIC B	---
TONE/DIRECT	MAGNAVOX A	MAGNAVOX B	MAGNAVOX C

**NOTE:**  
 Preset memory function will not work for some models or some codes.  
 In such case, please use the learning function.  
 (Page 12)

• Clearing the Preset Memory

1. Press the USE/LEARN selector button with the tip of a pen, etc., to set the learn mode.

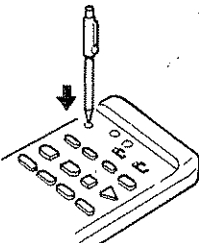

2. Set the slide switch to "VIDEO".



3. Set the program switch to the side to be cleared.

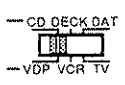

Ex.: To clear the VDP preset memory

4. Press the SYSTEM CALL SET button, and hold it in for at least four seconds.

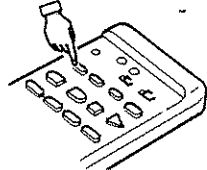

5. When both the START and LEARNED/TX LEDs light simultaneously, all the stored codes are cleared.

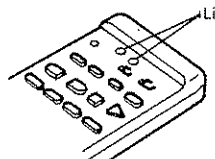
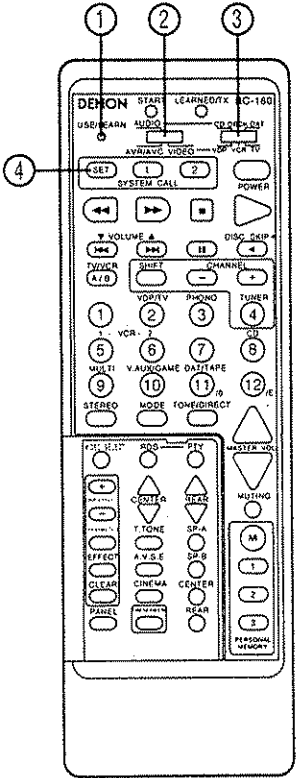
### 3-3 Remote Control Unit Learning Function

Use the learning function to operate audio components manufactured by companies other than Denon and when your VCR or TV does not operate with the preset memory function.

1. Press the USE/LEARN selector button with the tip of a pen etc., to set the learn mode. Both the START and LEARNED/TX indicators flash.

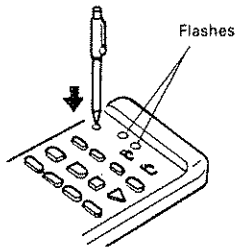

This unit's remote control unit

2. Set the program switch to the side to be "learned".  
Set to the AUDIO side for the CD, tape deck or DAT position, to the VIDEO side for the CDP, VCR or TV position.



3. Set the program switch to the position to be "learned".



4. Set the remote control units so they are facing each other, then press the button to be "learned" on this unit's remote control unit.

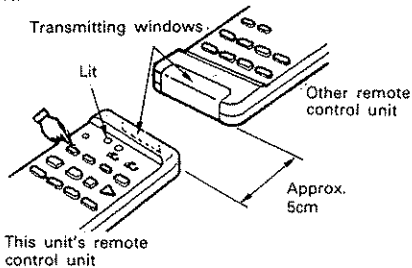

The indicator stops flashing and the START LED lights.

The learnable buttons are the buttons which can be operated with the DENON system codes for the CD player, DAT and tape deck, the buttons which can be operated with the preset memory for the VCR, VDP and TV. For the TV only, however, the buttons in the section indicated "A" on the diagram above can also be "learned". Use these to "learn" TV channels.

5. Check that the START LED is lit, then press the button to be "learned" on the other remote control unit.

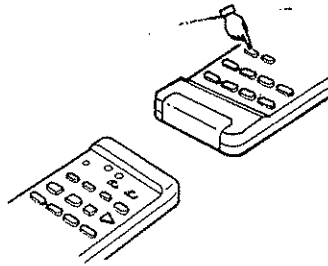

6. Once the START LED turns off and the LEARNED/TX LED lights, release the button on the other remote control unit.

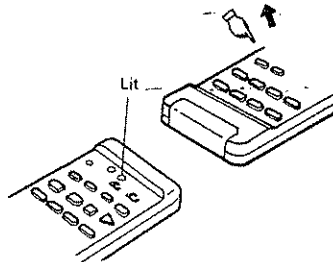

The two LEDs start flashing again.

7. To "learn" other buttons, repeat steps 4 and 5.

8. Once the learning operation is completed, press the USE/LEARN selector button again. The two LEDs stop flashing and the learning mode is cancelled.

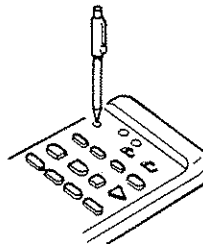

Check that the stored codes work properly.

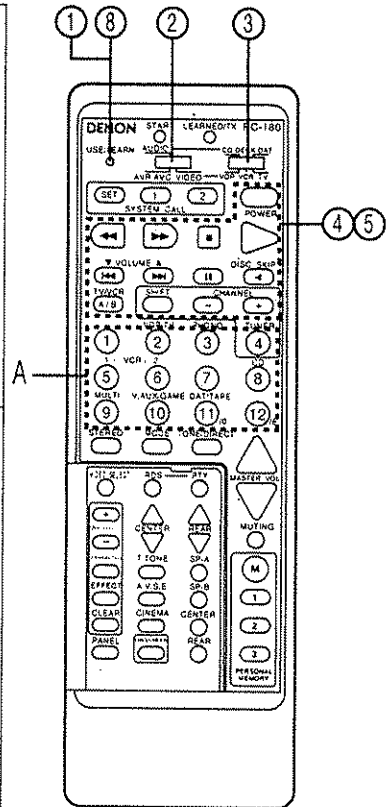

9. For instructions on resetting the "learned" codes, refer to "clearing the Preset Memory" on page 11.

#### NOTES:

- Up to 26 codes can be "learned", but this number may be lower if the codes are long.
- If a non-learnable button is pressed or two or more buttons are pressed at once, the two LEDs will once again light when the button(s) is released.
- If the codes could not be stored, the LEARNED/TX LED does not light after the START LED turns off. (This may happen for a limited number of models.)
- If the two LEDs start flashing rapidly after the START LED lights, this means that the memory is already full, and the code you have just attempted to store was not stored.  
To "learn" that code, first perform the resetting operation.

# 4 OPERATIONS

## 4-1 Preparations for Play Back

1. Check that all connections are proper.
2. Set to the minimum position.

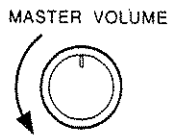

3. Set to the center position.

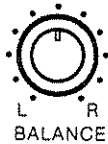

4. Set to the center position.

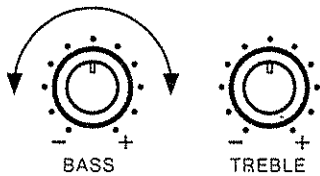

5. Set the remote control unit's slide switch to the AUDIO position.



6. Press the power button to turn the power on.

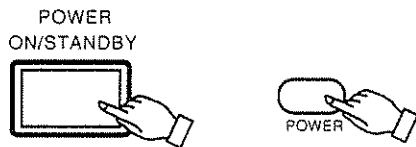

7. Select the front speakers. Press the speaker A or B button to turn the speaker on.

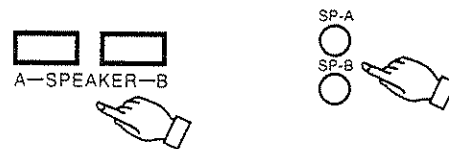

## 4-2 Playing the program source (Stereo play back)

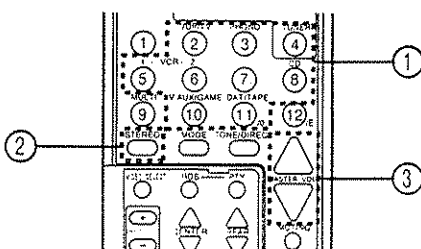
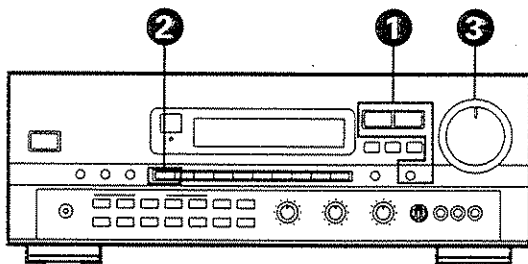

1. Select the source to be played.

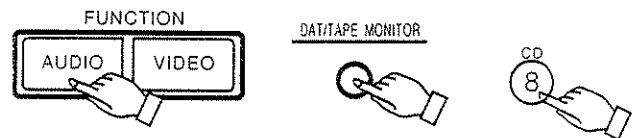

2. Select the STEREO mode.

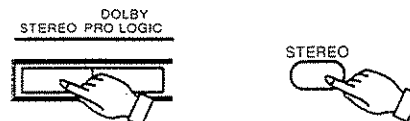

3. Adjust the MASTER VOLUME control.

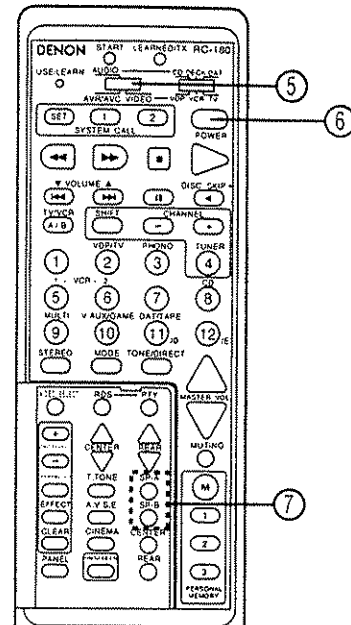
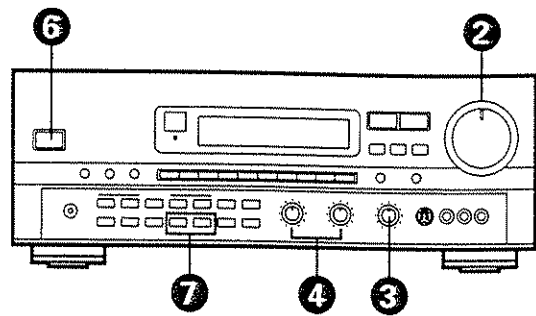
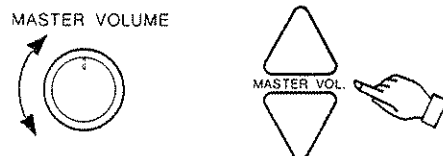

### 4-3 Adjusting the BALANCE control and TONE control

1. Adjust the front left/right BALANCE.

Turn the control counterclockwise to reduce the volume of the right channel, clockwise to reduce the volume of the left channel.

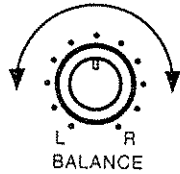

2. Adjust the BASS and TREBLE.

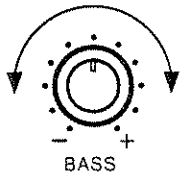

Turn the control clockwise to increase the bass, counterclockwise to decrease it.

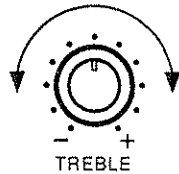

Turn the control clockwise to increase the treble, counterclockwise to decrease it.

3. A.V.S.E switch

Turn this switch on to create a powerful sound with even stronger low bass.

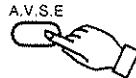

### 4-4 Simulcast playback

Use this switch to monitor a video source other than the audio source.

1. Press the VIDEO SELECT button repeatedly until the desired source appears on the display.



※ Cancelling simulcast playback

- Press the VIDEO SELECT button once more.
- Select the VIDEO function.

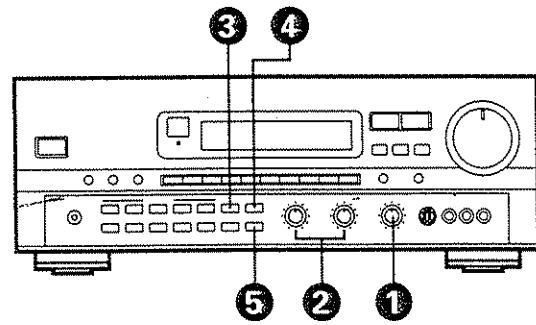
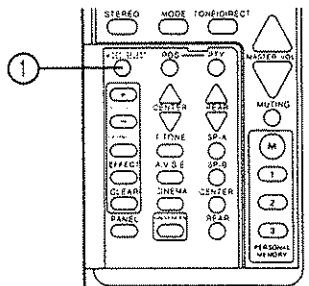

4. CINEMA EQ. switch

This button is used when playing back movie video software and the speech portion is felt to be harsh upon the ears. The output frequency response of the center and front speakers becomes closer to that in a theater and the sound becomes more pleasant to the ears.

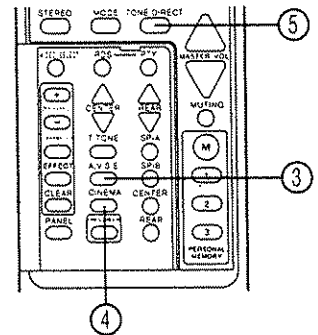
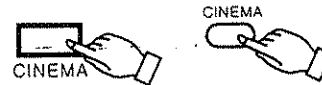

5. TONE DEFEAT switch

Use this when you do not want to adjust the sound. This can be used in the stereo mode.

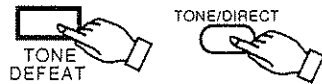

### 4-5 Using the muting function

Use this to turn off the audio output temporarily.

1. Press the MUTING button.
- ※ Cancelling MUTING mode.  
Press the MUTING button again.

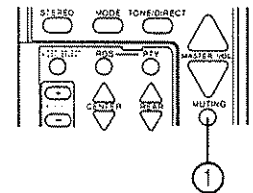

### 4-6 Listen with headphones

Connect the headphones to the PHONES jack.

When listening with headphones privately, set all SPEAKER switches to the OFF position.

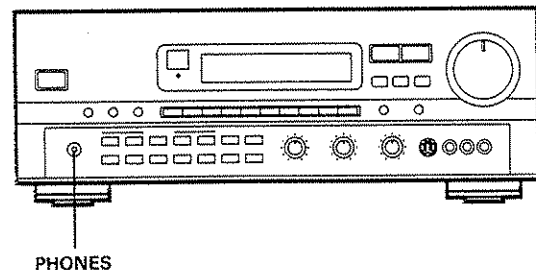

### 4-7 Multi-Source recording/playback

The Multi-Source function allows you to record a source other than the source currently playing or to output its signal to the MULTI SOURCE output terminal.

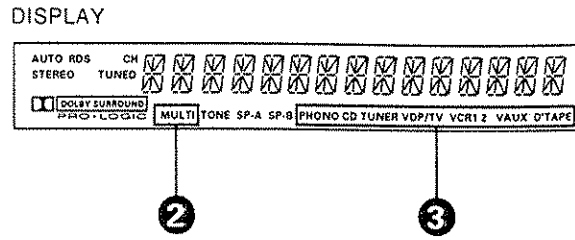
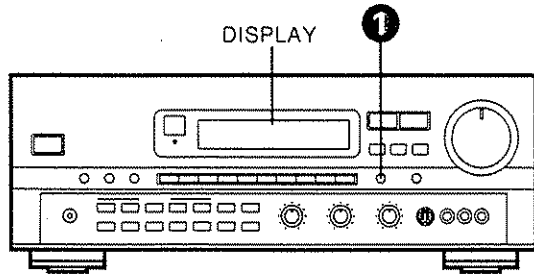

1. Select the source to be output to the recording or MULTI SOURCE output terminal.

2. Turn on the "MULTI" indicator.  
3. The selected source is indicated.

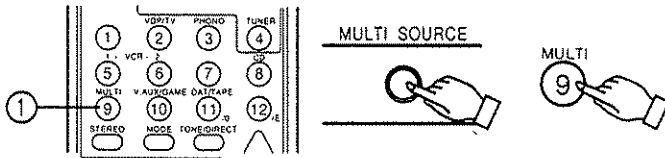

※ To cancel the multi-source mode and recording source selection  
Press the MULTI SOURCE button repeatedly until "Source" appears on the display.  
※ The VIDEO MONITOR output is automatically switched to V.AUX/GAME, when the input source is AUDIO and V.AUX/GAME is selected by Multi Source.

#### Multi-source and multi-zone playback

By connecting another pre-main amplifier, etc., to the MULTI SOURCE [OUT] jacks, you can listen to a source other than the one in the main room in other room. To connect the video signal, use a 75 Ω /ohms cable designed specifically for video signals. Using an improper cable can result in a drop in sound quality.

### 4-8 Using the surround function

This unit is equipped with a high precision D.S.P. (Digital Signal Processor) for processing signals digitally to simulate sound fields. Select the surround mode according to the playback source and adjust the parameters according to the conditions in the listening room to achieve a realistic, powerful sound.

#### Types of surround modes and their characteristics

1	Dolby Pro Logic	Use this when playing program sources recorded in Dolby Surround.
2	Wide Screen	Use this to enjoy program sources, recorded in Dolby Surround with the atmosphere of a movie theater.
3	Live Surround	Use this to enjoy program sources, recorded in Dolby Surround with the atmosphere of a live performance.
4	Super Stadium	Use this to enjoy program sources such as football or baseball games with the atmosphere of a stadium.
5	Mono Movie	In this mode, a sense of expansion is added to monaural audio sources. This mode is best suited for playing old movies or movie tapes recorded in monaural.
6	Rock Arena	The powerful reverberations of this mode produce a sound field which recreates the excitement of live concerts. This mode is effective for rock, popular music, etc.
7	Jazz Club	This mode creates the sound field of a live house with a low ceiling and hard reverberations. The result is that the artist seems to be performing right before your eyes.
8	Classic Concert	This mode creates a sound field simulating a large concert hall, rich in reverberation. This mode is characterized by composed acoustics, and is perfect for playing classical music, etc.
9	Matrix	Use this to enjoy stereo music sources with rich reverberations.

**• Before using the surround function**

Make the following adjustments before using the surround function.

1. Set the Dolby Pro Logic mode.



2. Select the center mode.  
Select the center mode according to the center speaker.



3. Emit the test tone.

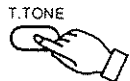

4. Select the auto sequence mode.



5. Adjust the center and rear levels to set the volume of the speakers to the same level.

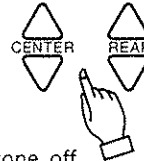

6. Turn the test tone off.

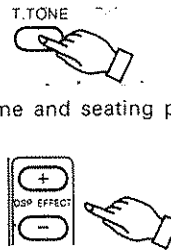

7. Adjust the delay time and seating position as necessary.

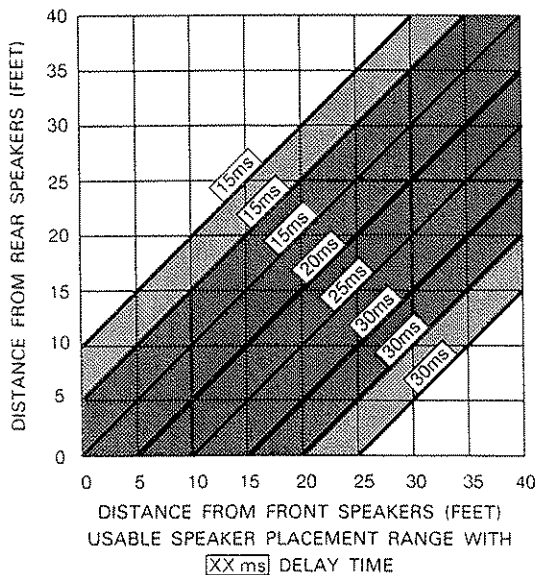
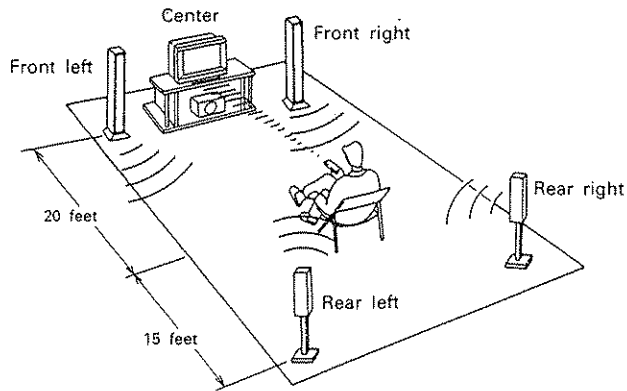
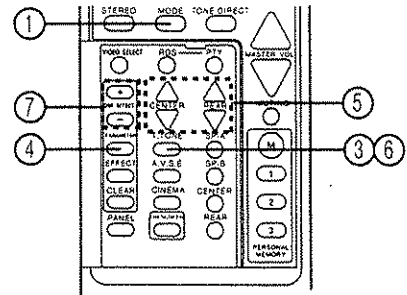
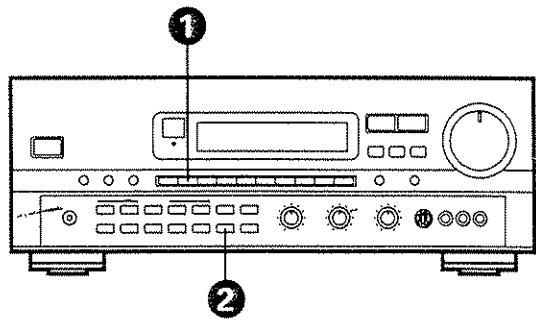
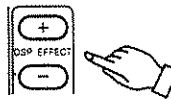

**Center Mode**

Set the center mode as described below, according to the type of center speaker being used.

**Normal mode:** This mode is suited for an arrangement in which the center channel speaker is smaller than the left and right speakers. Signals below 100 Hz which have almost no effect on directional orientation are distributed to the left and right channels, whereas the center channel output signals greater than 100 Hz. As a result, the bass of the left and right channels increases the apparent deepness of the sound.

**Wide mode:** This mode is suited for an arrangement in which the center channel speaker is of the same grade as the left and right speakers. The entire sound band from low region to high is output to the center channel to provide an exciting sound field for your enjoyment.

**Phantom mode:** Use this mode when center channel speaker is not used. A directional emphasis circuit provides signal reproduction which is electrically oriented to the center and this provides an exciting sound field for your enjoyment.

**Delay Time**

The optimum delay time will differ depending on the listening position. Referring to the chart at right, set the optimum delay time for your room's space and seating position. For example, when the distance from the front speakers to the listening position is 20 feet and that from the rear speakers to the listening position is 15 feet, the optimum delay time will be 20 ms. The variable range of the delay time differs depending on the mode.

- PREFERRED
- ▨ ACCEPTABLE
- NOT RECOMMENDED



● Using the surround function

1. Select the surround mode according to the input source.

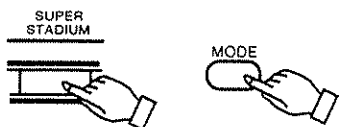

2. If necessary, adjust the levels.

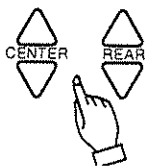

3. Adjust the parameters to the desired settings.

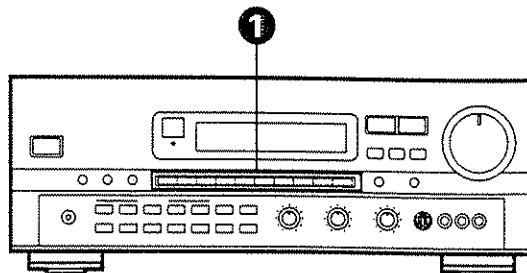
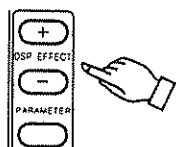

4. To check the DSP effect, press the EFFECT button to turn the effect on and off.



5. To set the parameters back to the standard settings, press the CLEAR button.

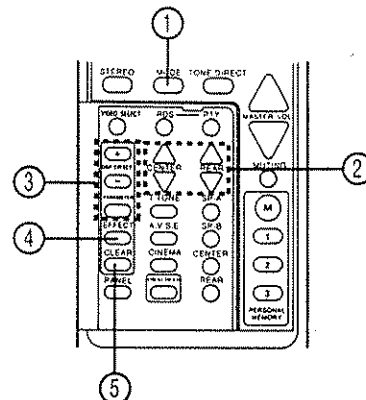

● Surround modes and parameters

- DELAY TIME ..... This can be set to between 15 and 30 msec for the DOLBY PRO LOGIC mode, between 0 and 360 msec for the MATRIX mode. It is controlled directly with the DSP EFFECT "+" and "-" buttons. These parameters can be used in modes other than the DOLBY PRO LOGIC and MATRIX modes.
- ROOM SIZE ..... "Room size" refers to the size of the sound field.
- EFFECT LEVEL ..... "Effect level" refers to the strength of the effect sounds. If the sound is distorted or seems strange, lower the level.
- EFFECT ..... This can be used in surround modes other than DOLBY PRO LOGIC, WIDE SCREEN, LIVE SURROUND and MATRIX MODE.
- CENTER LEVEL ..... This can be used in the DOLBY PRO LOGIC, WIDE SCREEN, and LIVE SURROUND modes when the center mode is set to the normal or wide mode. In other cases, the center output is automatically turned off.
- CENTER MODE ..... When this is selected in the DOLBY PRO LOGIC mode, the wide screen and live mode center modes are automatically set.

● Using the Personal Memory function

The personal memory function allows you to store the current input position and surround mode in memory. Both settings can then be recalled instantly by pressing a single button.

Presetting

1. Set the desired input position and surround mode using the procedures described in sections 4-2 and 4-8.
2. Press the Personal memory "MEMORY" button. The standby mode is set.



3. Press the button (1 to 3) at which you want to store the setting.



The setting is now stored.

Recalling

4. Press the button (1, 2 or 3) at which the desired setting has been stored. The unit automatically switches to that setting.

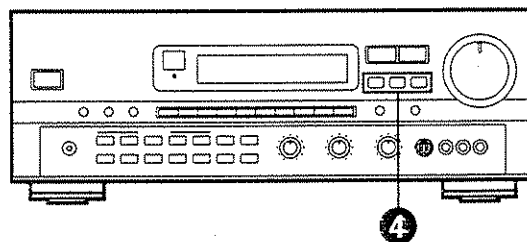
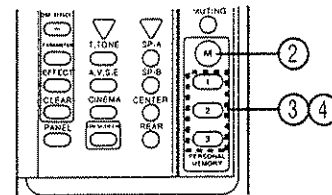
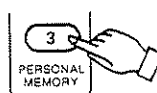
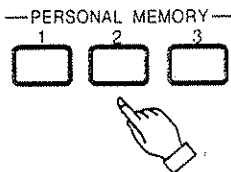

※ The DAT/TAPE MONITOR position cannot be stored in the memory.

## 5 LISTENING TO THE RADIO

### 5-1 Auto preset memory

This unit is equipped with a function for automatically searching for FM broadcast stations and storing them in the preset memory.

1. Press the POWER button while holding in the MEMORY button. The unit automatically begins searching for FM broadcast stations.

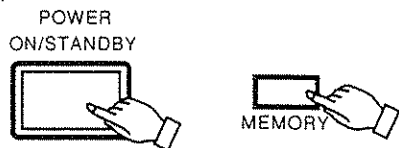

2. When the first FM broadcast station is found, that station is stored in the preset memory at channel A1. Subsequent stations are automatically stored in order at preset channels A2 to A8, B1 to B8, C1 to C8 and D1 to D8, for a maximum of 32 stations.

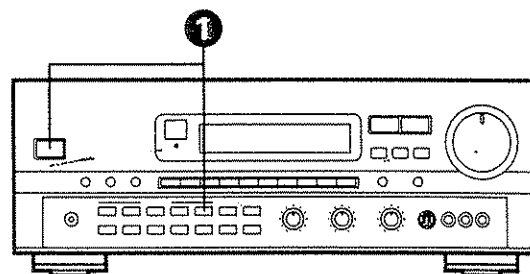

3. Channel A1 is tuned in after the auto preset memory operation is completed.

#### NOTES:

- If an FM station cannot be preset automatically due to poor reception, use the "Manual tuning" operation to tune in the station, then preset it using the manual "Preset memory" operation.
- RDS stations are stored in the memory with priority.

### 5-2 Auto tuning

1. Set the input function to "TUNER".

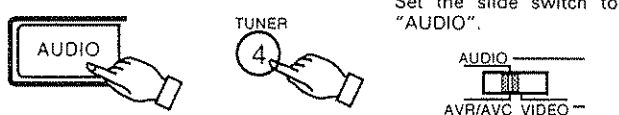

2. Watching the display, press the BAND button to select the desired band (AM or FM).

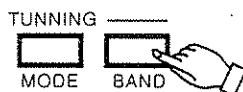

3. Press the MODE button to set the auto tuning mode.
4. Press the TUNING UP or DOWN button.

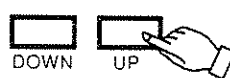

"AUTO" appears on the display.

Automatic searching begins, then stops when a station is tuned in.

If tuning does not stop at the desired station, use the "Manual tuning" operation.

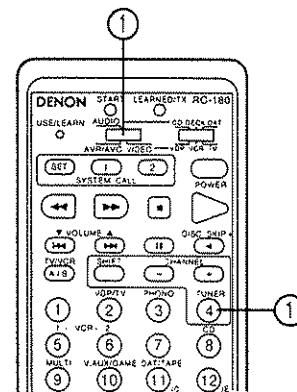
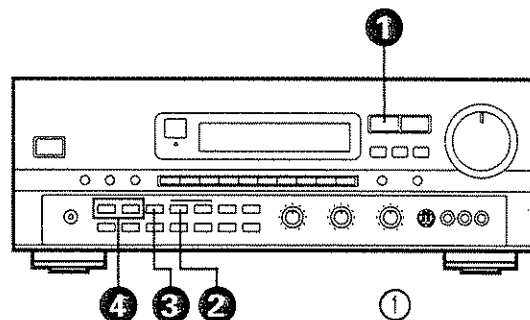

### 5-3 Manual tuning

1. Set the input function to "TUNER".
2. Watching the display, press the BAND button to select the desired band (AM or FM).
3. Press the MODE button to set the manual tuning mode. Check that the display's "AUTO" indicator turns.

4. Press the TUNING UP or DOWN button to tune in the desired station. The frequency changes continuously when the button is held in.

### 5-4 Preset memory

1. Use the "Auto tuning" or "Manual tuning" operation to tune in the station to be preset in the memory.
2. Press the MEMORY button.

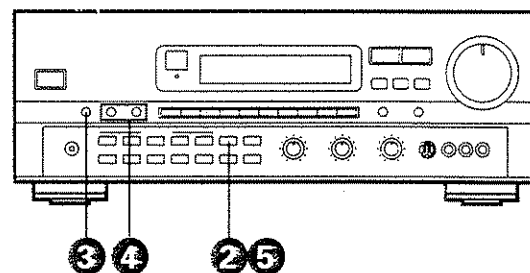

- Press the SHIFT button and select the desired memory block (A to D).
- Press the PRESET UP or DOWN button to select the desired preset channel (1 to 8).

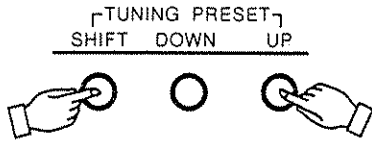

- Press the MEMORY button again to store the station in the preset memory.



To preset other channels, repeat steps 2 to 5. A total of 32 broadcast stations can be preset — 8 stations (channels 1 to 8) in each of blocks A to D.

### 5-5 Recalling preset stations

- Watching the display, press the SHIFT button to select the preset memory block.



- Watching the display, press the PRESET UP or DOWN button to select the desired preset channel.

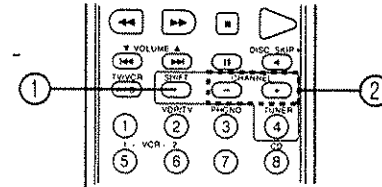
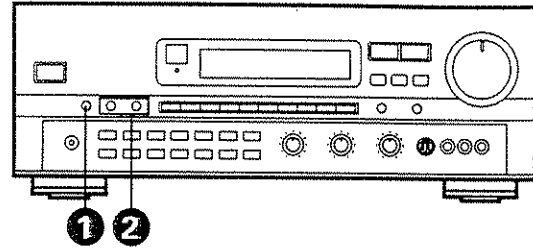
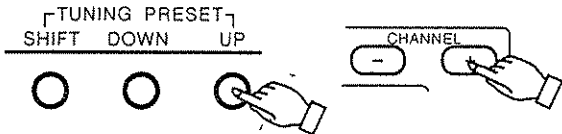

### 5-6 RDS (Radio Data System)

RDS (works only on the FM band) is a broadcasting service which allows station to send additional information along with the regular radio program signal.

The following three types of RDS information can be received on this unit:

#### • Program Type (PTY)

PTY identifies the type of RDS program.

The program types and their displays are as follows:

NEWS	News	TOP 40	Top 40	SOFT R&B	Soft R & B
INFORM	Information	COUNTRY	Country	LANGUAGE	Language
SPORTS	Sports	OLDBIES	Oldies	REL MUSIC	Religious Music
TALK	Talk	SOFT	Soft	REL TALK	Religious Talk
ROCK	Rock	NOSTALGA	Nostalgia	PERSNLIY	Personality
CLS ROCK	Classic Rock	JAZZ	Jazz	PUBLIC	Public
ADULT HIT	Adult Hits	CLASSICL	Classical		
SOFT RCK	Soft Rock	R & B	R & B		

#### • Traffic Program (TP)

TP identifies programs that carry traffic announcements.

This allows you to easily find out the latest traffic conditions in your area before you leaving home.

#### • Radio Text (RT)

RT allows the RDS station to send text messages that appear on the display.

### 5-7 RDS search

Use this function to automatically tune to FM stations that provide RDS service.

1. Set the input function to "TUNER".

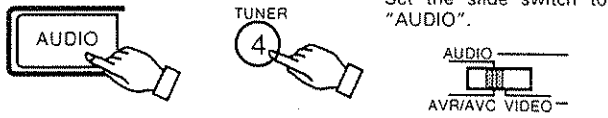

2. Press the RDS button until "RDS SEARCH" appears on the display.



3. Press the PRESET UP or DOWN button to automatically begin the RDS search operation.

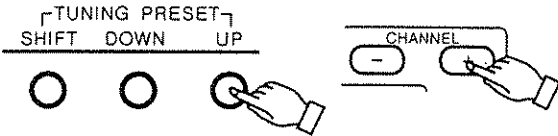

If no RDS stations is found with above operation, all the reception band are searched.

4. When a broadcast station is found, that station's name appears on the display.
5. To continue searching, repeat step 3. If no other RDS station is found when all the frequencies are searched, "NO RDS" is displayed.

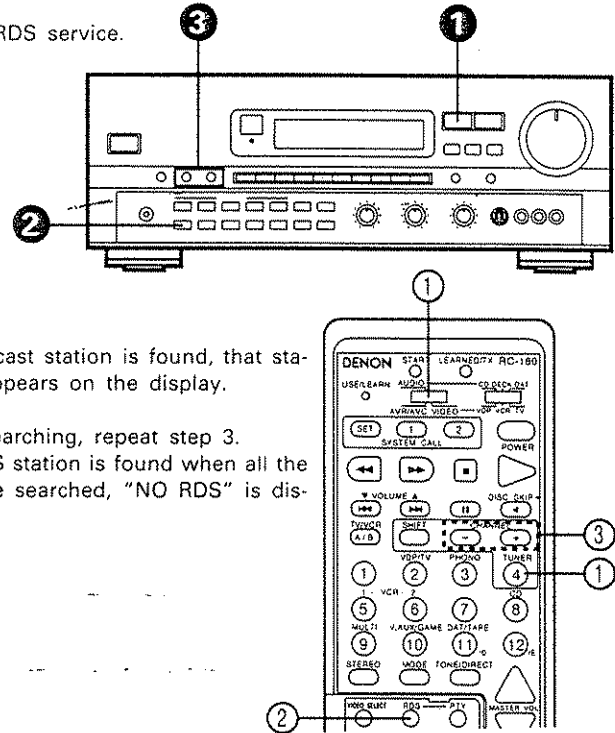

### 5-8 PTY search

Use this function to find RDS stations broadcasting a designated program type (PTY). For a description of each program type, refer to "Program Type (PTY)".

1. Set the input function to "TUNER".

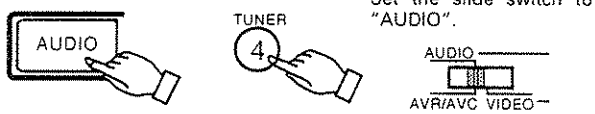

2. Press the RDS button until "PTY SEARCH" appears on the display.



3. Watching the display, press the PTY button to call out the desired program type.



4. Press the PRESET UP or DOWN button to automatically begin the PTY search operation.

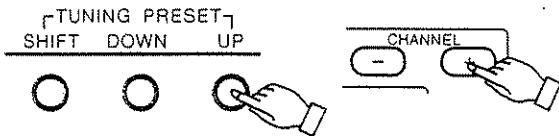

If there is no station broadcasting the designated programme type with above operation, all the reception bands are searched.

5. The station name is displayed on the display after searching stops.
6. To continue searching, repeat step 4. If no other station broadcasting the designated program type is found when all the frequencies are searched, "NO PROGRAM" is displayed on the display.

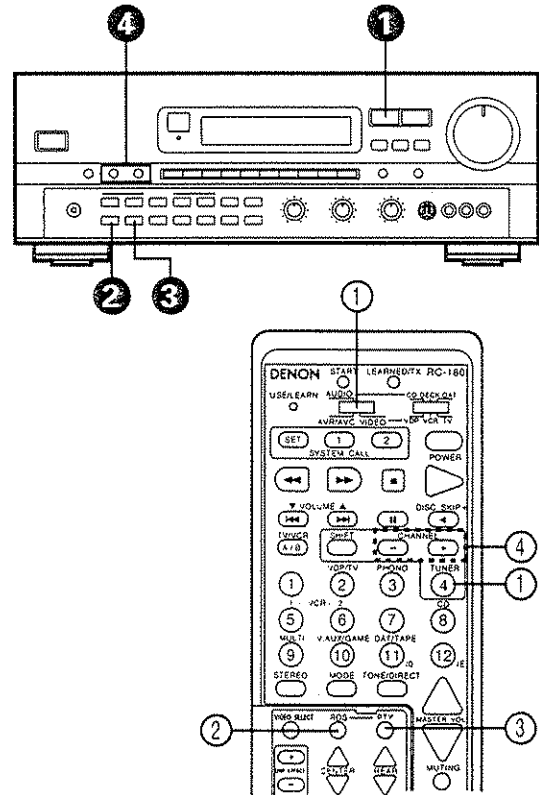

## 5-9 TP search

Use this function to find RDS stations broadcasting traffic program (TP stations).

1. Set the input function to "TUNER".

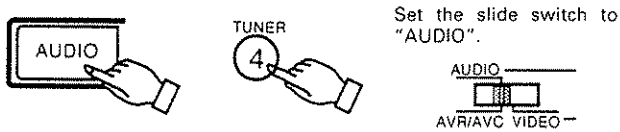

2. Press the RDS button until "TP SEARCH" appears on the display.



3. Press the PRESET UP or DOWN button TP search begins.

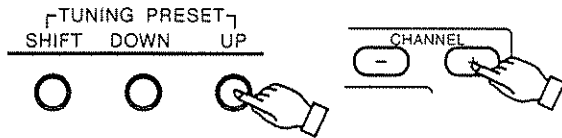

If no TP station is found with above operation, all the reception bands are searched.

4. The station name is displayed after searching stops.
5. To continue searching, repeat step 3.  
If no other TP station is found when all the frequencies are searched, "NO PROGRAM" is displayed.

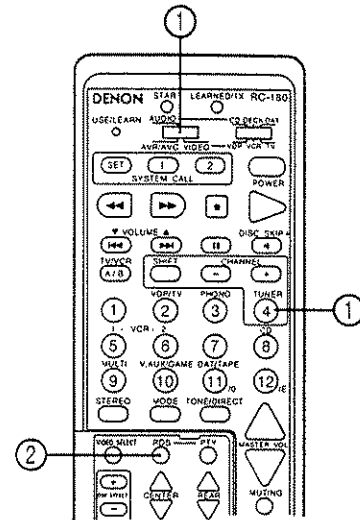
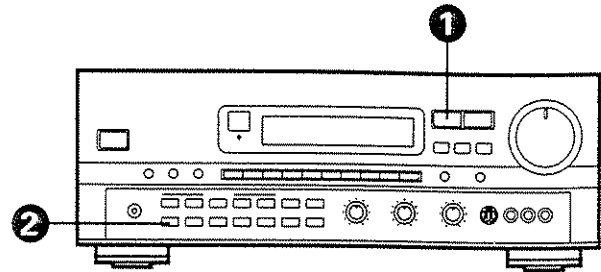

## 5-10 RT (Radio Text)

"RT" appears on the display when radio text data is received.

When the RT button is pressed while receiving an RDS broadcast station, the text data broadcast from the station is displayed. To turn the display off, press the RT button again. If no text data is being broadcast, "NO TEXT DATA" is displayed.

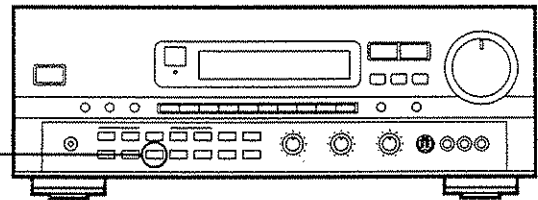

## • RDS Emergency Alert

"ALERT" will flash on the MFD when the unit receives the Emergency Program Type Code (PTY31) from an RDS station. This feature may not operate properly if the signal from the RDS station is too weak or is subjected to interference. It is not possible to select the "ALERT" display from the PTY search mode.

### RDS Emergency Alert Feature

The RDS Emergency Alert Feature is activated by a signal sent at the sole discretion of the RDS broadcaster. The RDS Emergency Alert Feature is included in this product for the convenience of the consumer, and is not intended to augment or replace the Official Emergency Broadcast System as administered by the Federal Communications Commission. For this reason, Nippon Columbia Co. and its Subsidiaries, including but not limited to DENON America, Inc. and DENON Canada, Inc., refuse all Warranties, claims of merchantability or fitness, or liabilities, whether incidental, consequential or otherwise, related to, either directly or indirectly, the operation or lack of operation of this feature. This exclusion applies to any and/or all Nippon Columbia co. Products, whether present or future, that implement, in any form or variation, the RDS Emergency Alert Feature.

## 6 EASY OPERATION FUNCTIONS

This unit is equipped with the functions described below to make operation simpler.

### 6-1 On-screen display

Each time an operation is performed, a description of that operation appears on the display connected to the unit's VIDEO MONITOR OUT terminal. Also, the unit's operating status can be checked during playback by pressing the remote control unit's ON SCREEN button.

Such information as the position of the input selector and the surround parameter settings is output in sequence.

The output from the S MONITOR OUT terminal has priority for the on-screen display. If you want to always output the on-screen display signals to the video output, do not connect a cable to the S MONITOR OUT terminal.

The on-screen display is not displayed for the MULTI SOURCE MONITOR OUT terminal.

This model's on-screen function is designed for high resolution monitor displays. Small characters may be difficult to read on small displays or low resolution TVs.

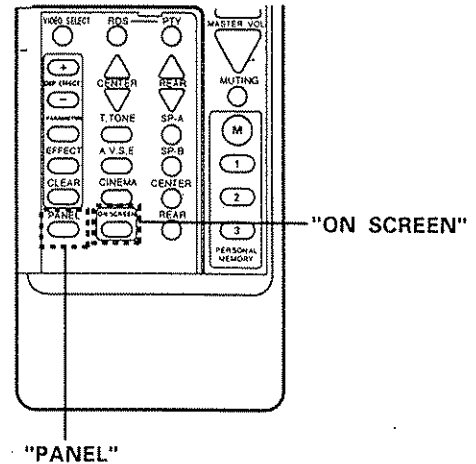

### 6-2 Front panel display

Descriptions of the unit's operations are also displayed on the front panel display. In addition, the display can be switched to check the unit's operating status while playing a source by pressing the remote control unit's PANEL button.

### 6-3 Personal memory

This is a function allowing you to easily set the input position and surround mode with a single button once the input selector and surround mode have been preset.

For details, refer to Page 17.

### 6-4 System call (Remote control unit)

This function allows you to preset frequently used operation patterns in the remote control unit then automatically send a series of up to ten remote control codes with a single button.

#### Presetting

1. Press the SET button.



2. Press the buttons for the codes to be sent, changing the position of the slide switch as necessary. (Up to ten buttons can be set.) Buttons which have been "learned" and buttons which have been preset can also be selected.

3. Press the SYSTEM CALL button ("1" or "2") at which you want to store the codes. The setting is now stored.

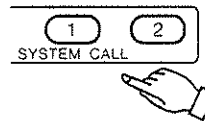

#### Recalling

4. Press the SYSTEM CALL button ("1" or "2") at which the desired codes have been stored. The series of codes is now sent.

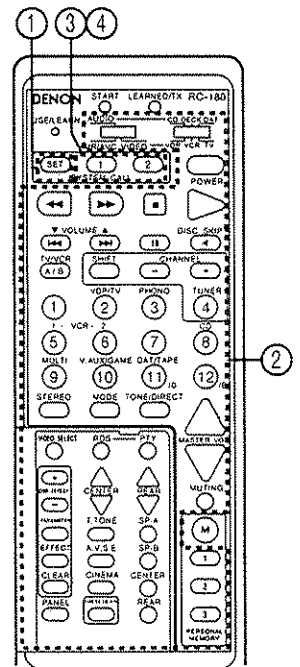
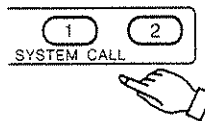

## 7 INITIALIZATION OF THE MICROPROCESSOR

When the indication of the MFD display is not normal or when the operation of the unit does not show the reasonable result, the initialization of the microprocessor is required by the following procedure.

1. Switch off the unit and remove the AC power cord from the wall outlet.
2. Hold the following AUDIO FUNCTION button and VIDEO FUNCTION button, and plug the power cord into the outlet.
3. Check that the entire display is flashing with an interval of about 1 second, and release your fingers from the 2 buttons.
4. Switch on the unit and the microprocessor will be initialized.

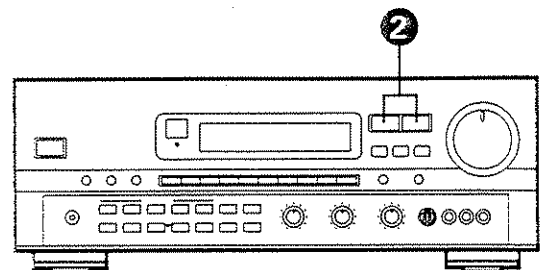

## 8 LAST FUNCTION MEMORY

- This receiver is equipped with a last function memory which stores the input and output setting conditions as they were immediately before the power is switched off. This function eliminates the need to perform complicated resettings when the power is switched on.
- This receiver is also equipped with a back-up memory. This function provides approximately one week of memory storage with the power cord disconnected.

## 9 TROUBLESHOOTING

If a problem should arise, first check the following:

1. Are the connections correct?
2. Have you operated the amplifier according to the Operating Instructions?
3. Are the speakers, turntable, and other components operating properly?

If the receiver is not operating properly, check the items listed in the table below. Should the problem persist, there may be a malfunction. Disconnect the power immediately and contact your store of purchase.

	Symptom	Cause	Measures	Page
Common problems arising when listening to the CD, records, tapes, and FM broadcasts, etc.	DISPLAY not lit and sound not produced when power switch set to on.	<ul style="list-style-type: none"> <li>• Power cord not plugged in securely.</li> </ul>	<ul style="list-style-type: none"> <li>• Check the insertion of the power cord plug.</li> </ul>	5
	DISPLAY lit but sound not produced.	<ul style="list-style-type: none"> <li>• Speaker cords not securely connected.</li> <li>• Speaker switch is off.</li> <li>• Improper position of the audio function button.</li> <li>• Volume control set to minimum.</li> <li>• MUTING is on.</li> </ul>	<ul style="list-style-type: none"> <li>• Connect securely.</li> <li>• Turn on speaker switch.</li> <li>• Set to a suitable position.</li> <li>• Turn volume up to suitable level.</li> <li>• Switch off MUTING.</li> </ul>	5, 6 13 13 13 14
	–PROTECT– display appears.	<ul style="list-style-type: none"> <li>• Speaker terminals are short-circuited.</li> <li>• Block the ventilation holes of the set.</li> <li>• The unit is operating at continuous high power conditions and/or inadequate ventilation.</li> </ul>	<ul style="list-style-type: none"> <li>• Switch power off, connect speakers properly, then switch power back on.</li> <li>• Turn off the set's power, then ventilate it well to cool it down. Once the set is cooled down, turn the power back on.</li> <li>• Turn off the set's power, then ventilate it well to cool it down. Once the set is cooled down, turn the power back on.</li> </ul>	5, 6 4 4
	Sound produced only from one channel.	<ul style="list-style-type: none"> <li>• Incomplete connection of speaker cords.</li> <li>• Incomplete connection of input/output cords.</li> <li>• Left/right balance is off.</li> </ul>	<ul style="list-style-type: none"> <li>• Connect securely.</li> <li>• Connect securely.</li> <li>• Adjust balance knob properly.</li> </ul>	5, 6 5~7 14
	Positions of instruments reversed during stereo playback.	<ul style="list-style-type: none"> <li>• Reverse connections of left and right speakers or left and right input/output cords.</li> </ul>	<ul style="list-style-type: none"> <li>• Check left and right connections.</li> </ul>	5~7
	Sound seems distorted.	<ul style="list-style-type: none"> <li>• Effect level parameter is high.</li> <li>• Rear level is too high.</li> </ul>	<ul style="list-style-type: none"> <li>• Set the effect level parameter to lower level.</li> <li>• Set the rear level to lower level.</li> </ul>	17 17
	Sound seems strange.	<ul style="list-style-type: none"> <li>• DSP parameter settings are poor.</li> </ul>	<ul style="list-style-type: none"> <li>• Press the CLEAR button then adjust the DSP parameters.</li> </ul>	17
	Personal memory function does not work.	<ul style="list-style-type: none"> <li>• DAT/tape monitor mode set.</li> </ul>	<ul style="list-style-type: none"> <li>• The DAT/TAPE MONITOR position cannot be set in the personal memory.</li> </ul>	17
	When playing records	Humming noise produced when record is playing.	<ul style="list-style-type: none"> <li>• Ground wire of turntable not connected properly.</li> <li>• Incomplete PHONO jack connection.</li> <li>• TV or radio transmission antenna nearby.</li> </ul>	<ul style="list-style-type: none"> <li>• Connect securely.</li> <li>• Connect securely.</li> <li>• Contact your store of purchase.</li> </ul>
Howling noise produced when volume is high.		<ul style="list-style-type: none"> <li>• Turntable and speaker systems too close together.</li> <li>• Floor is unstable and vibrates easily.</li> </ul>	<ul style="list-style-type: none"> <li>• Separate as much as possible.</li> <li>• Use cushions to absorb speaker vibrations transmitted by floor. If turntable is not equipped with insulators, use audio insulators (commonly available).</li> </ul>	– –
Sound is distorted.		<ul style="list-style-type: none"> <li>• Stylus pressure too weak.</li> <li>• Dust or dirt on stylus.</li> <li>• Cartridge defective.</li> </ul>	<ul style="list-style-type: none"> <li>• Apply proper stylus pressure.</li> <li>• Check stylus.</li> <li>• Replace cartridge.</li> </ul>	– – –
Volume is weak.		<ul style="list-style-type: none"> <li>• MC cartridge being used.</li> </ul>	<ul style="list-style-type: none"> <li>• Replace with MM cartridge or use a head amplifier or step-up transformer.</li> </ul>	5
Remote control unit	Receiver does not operate properly when remote control unit is used.	<ul style="list-style-type: none"> <li>• Batteries dead.</li> <li>• Remote control unit too far from receiver.</li> <li>• Obstacle between receiver and remote control unit.</li> <li>• Different button is being pressed.</li> <li>• ⊕ and ⊖ ends of battery inserted in reverse.</li> </ul>	<ul style="list-style-type: none"> <li>• Replace with new batteries.</li> <li>• Move closer.</li> <li>• Remove obstacle.</li> <li>• Press the proper button.</li> <li>• Insert batteries properly.</li> </ul>	9 9 9 9

## 10 SPECIFICATIONS

- Audio Section**  
**(Power amplifier)**  
**Rated output:**  
 (All properties shown are only for the power amplifier stage.)
 

	for North America model	for multi-Voltage model
MAIN (main 2ch driven)	85 W + 85 W (8 Ω / ohms, 20 Hz – 20 kHz with 0.05% THD)	110 W + 110 W (6 Ω / ohms, EIAJ)
CENTER (center 1ch driven)	85 W (8 Ω / ohms, 20 Hz – 20 kHz with 0.05% THD)	110 W (6 Ω / ohms, EIAJ)
REAR (rear 2ch driven)	25 W + 25 W (8 Ω / ohms, 1 kHz with 0.1% THD)	30 W + 30 W (6 Ω / ohms, EIAJ) at Dolby PRO LOGIC WIDE MODE
  
- Output terminals:**

Main:	A or B 6 to 16 Ω / ohms
	A + B 12 to 16 Ω / ohms
Center:	6 to 16 Ω / ohms
Rear:	6 to 16 Ω / ohms
  
- (Pre-amplifier)**  
**Line input (Each line input – FRONT PRE OUT)**  
**Input sensitivity / impedance:** 150 mV / 47 k Ω / ohms PHONO (MM): 2.5 mV / 47 k Ω / ohms  
**Frequency response:** 10 Hz to 50 kHz: ±3 dB  
**Tone control range:**

BASS:	±10 dB at 100 Hz
TREBLE:	±10 dB at 10 kHz
  
- Signal-to-noise ratio (FRONT PRE OUT):** 92 dB  
**Distortion factor:** 0.01% 1 kHz 1 V (STEREO mode)  
**Maximum headphone output:** 284 mW (8 Ω / ohms)  
**Phono equalizer (PHONO input – REC OUT)**  
**RIAA deviation:** ±1 dB (20 Hz to 20 kHz)  
**Signal-to-noise ratio:** 74 dB (A weighting, with 5 mV input)  
**Rated output / Maximum output:** 150 mV / 8 V  
**Distortion factor:** 0.03% (1 kHz, 3 V)
  
- Tuner Section**

	<b>[FM]</b> (note: $\mu\text{V}$ at 75 Ω / ohms, 0 dBf = $1 \times 10^{-15}$ W)	<b>[AM]</b>
<b>Receiving Range:</b>	87.5 MHz ~ 107.9 MHz (for North America model) 87.50 MHz ~ 108.00 MHz (for multi-voltage model)	520 kHz ~ 1710 kHz (for North America model) 522 kHz ~ 1611 kHz (for multi-voltage model)
<b>Usable Sensitivity:</b>	1.0 $\mu\text{V}$ (11.2 dBf)	18 $\mu\text{V}$
<b>50 dB Quieting Sensitivity:</b>	MONO 1.6 $\mu\text{V}$ (15.3 dBf) STEREO 23 $\mu\text{V}$ (38.5 dBf)	
<b>Signal to Noise Ratio (IHF-A):</b>	MONO 80 dB STEREO 75 dB	50 dB
<b>Total Harmonic Distortion (at 1 kHz):</b>	MONO 0.15% STEREO 0.3%	
  
- Video Section**  
**Standard video jacks**  
**Input and output level / impedance:** 1 Vp-p / 75 Ω / ohms  
**Frequency response:** 5 Hz to 8 MHz +0, -3 dB  
**S-video output jacks**  
**Input and output level / impedance:** Y (brightness) signal: 1 Vp-p / 75 Ω / ohms  
 C (color) signal: 0.286 Vp-p / 75 Ω / ohms  
**Frequency response:** 5 Hz to 10 MHz +0, -3 dB
  
- General**  
**Power supply:** AC 120 V, 60 Hz (for North America model)  
 AC 115/230 V, 50/60 Hz (for multi-voltage model)  
**Power consumption:** 5.0 A (for North America model)  
 270 W (for multi-voltage model)  
**Maximum external dimensions:** 434 (W) × 161 (H) × 433 (D) mm (17-3/32" × 6-11/32" × 17-3/64") (without side wood boards model)  
 470 (W) × 142 (H) × 433 (D) mm (18-1/2" × 6-3/8" × 17-3/64") (with side wood boards model)  
**Weight:** 11.7 kg (25 lbs 13 oz) (without side wood boards model)  
 13.0 kg (28 lbs 11 oz) (with side wood boards model)
  
- Remote control unit (RC-180)**  
**Batteries:** R6P/AA Type (two batteries)  
**External dimensions:** 70 (W) × 215 (H) × 19 (D) mm (2-3/4" × 8-15/32" × 3/4")  
**Weight:** 180 g (Approx. 6 oz) (including batteries)

## NIPPON COLUMBIA CO., LTD.

14-14, AKASAKA 4-CHOME, MINATO-KU, TOKYO 107-11, JAPAN  
 Telephone: (03) 3584-8111  
 Cable: NIPPON COLUMBIA TOKYO Telex: JAPANOLA J22591